

SENA

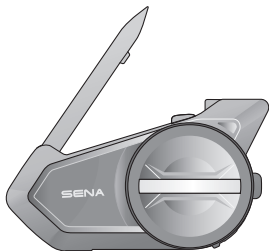

SOS

메시 인터콤™ 지원 모터사이클 블루투스® 통신 시스템

HD SPEAKERS

빠른 시작 가이드

RIDE CONNECTED

50S는 신뢰할 수 있는 디자인과 함께 하드웨어와 소프트웨어 모두 크게 업그레이드 되었습니다. 메시 인터콤™ 기술과 함께 완전히 새로운 라이딩 경험을 즐기십시오.



메시 인터콤™ 최대 거리 2 km*



블루투스® 5.0



오디오 멀티태스킹™



HD 스피커



인터콤 최대 거리 2.0 km*



다자 인터콤



- 다국어 음성 명령
- 시리 및 구글 어시스턴트 지원

* 전파간섭이 없는 개방 지형에서 사용할 때

시작하기

1. 이 제품에는 사용자 설명서의 기본 버전인 빠른시작 가이드가 제공됩니다. **전체 사용자 설명서**는 senakorea.kr에서 다운로드 하십시오.
2. 최신 펌웨어로 업데이트하고 제품에 추가된 새롭고 유용한 기능들을 사용해 보십시오. senakorea.kr에서 펌웨어 업데이트 방법을 자세히 알아보십시오.
3. Facebook과 YouTube에서 '세나코리아'를 팔로우 하시고 최신 정보, 유용한 팁 및 제품에 대한 공지사항 등을 받아 보십시오.

SENA
BLUETOOTH KOREA

세 나 블루투스 코리아

웹 사이트 www.senakorea.kr
지원 support@senakorea.kr
온라인샵 senakorea.kr/shop
 YouTube youtube.com/SenaKorea

시작하기

가이드 보는 방법

삽화와 기호를 통해서 제품의 사용법을 설명합니다. 새로운 기능들이 다소 생소하겠지만 표시된 방법들을 따르면 쉽게 조작할 수 있을 것입니다.



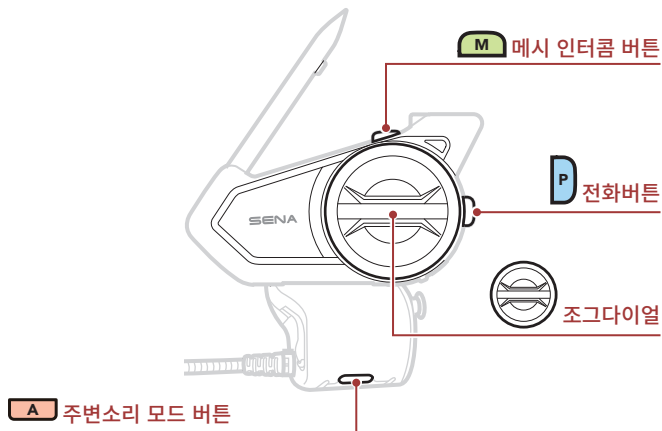

버튼









시작하기

아이콘 일러두기

 **살짝 누르기** 버튼/조그다이얼을
지정된 횟수만큼 누르기

 **길게 누르기** 버튼/조그다이얼을
지정된 시간 동안 누르고 있기

   **돌리기** 조그다이얼을 시계 방향(오른쪽) 또는 반시계 방향
(왼쪽)으로 돌리기

   **누른 상태로 돌리기** 조그다이얼을 누른 상태로 시계 방향
(오른쪽) 또는 반시계 방향(왼쪽)으로 돌리기



"Hello/안녕하세요"

음성안내

빠른 시작 가이드

제품 상세

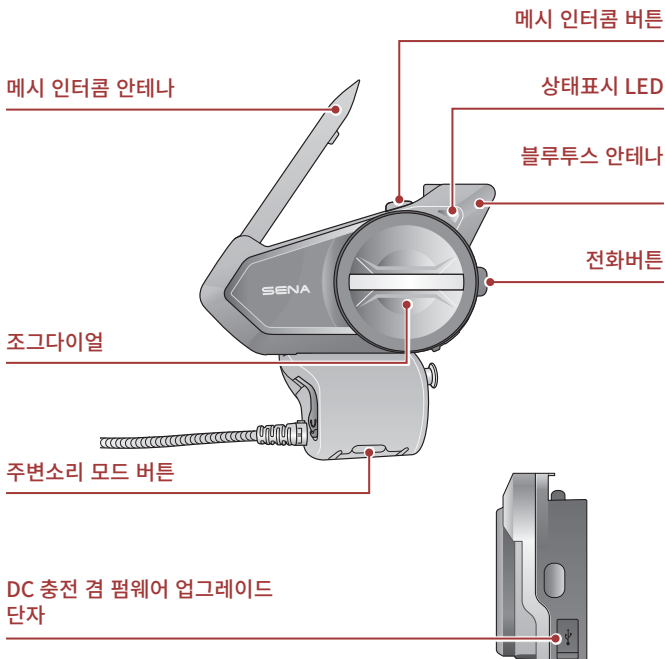

빠른 시작 가이드

설치

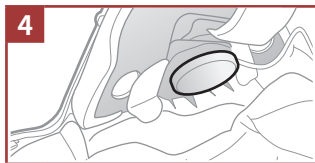
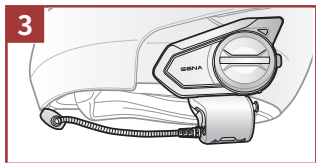
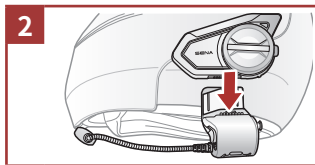
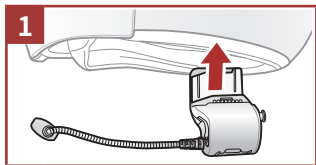

메시 인터콤 안테나

메시 인터콤 안테나를 바깥쪽으로 살짝 당기면 펴집니다.

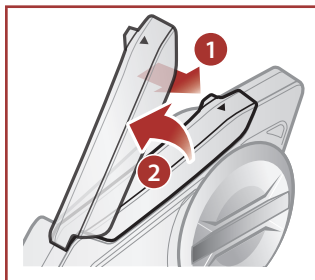

빠른 시작 가이드

Sena 50 Utility 앱

휴대전화와 헤드셋을 페어링한 후에 **세나 50 유틸리티 앱**을 사용하여 빠르고 쉽게 설정하고 관리할 수 있습니다.

- 앱 기능
 - 메시 인터콤, 블루투스 인터콤, 음악, 기기 설정, 빠른 시작 가이드, 사용자 설명서
- 다운로드
 - 안드로이드: 구글 플레이 스토어 > 'Sena 50 Utility'
 - iOS: 앱스토어 > 'Sena 50 Utility'



세나 디바이스 매니저

세나 디바이스 매니저를 통해 PC 또는 Apple 컴퓨터에서 펌웨어 업그레이드와 장치 설정을 쉽게 할 수 있습니다. www.senakorea.kr에서 **세나 디바이스 매니저**를 다운로드 하십시오.

빠른 시작 가이드

기본 조작

전원 켜기



전원 끄기



음량 키우기



음량 줄이기



배터리 잔량 확인

이 방법은 헤드셋을 켤 때 사용할 수 있습니다.

LED로 확인



빠른 시작 가이드

휴대전화 페어링

휴대전화 페어링

50S를 끈 상태에서 **전화버튼**과 **조그다이얼**을 **3초** 동안 누르십시오.



블루투스
LED 상태

파란색과 빨간색이 번갈아 깜빡이면 **휴대전화에서 기기를 검색하십시오.**
휴대전화의 블루투스 페어링 화면에서 검색된 기기 목록 중에 **Sena 50S**를
선택하십시오.

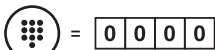

핀 번호

휴대전화

전화 받기



전화 끊기



또는

전화 거절하기



빠른 시작 가이드

시리 및 구글 어시스턴트

스마트폰에 설치된 시리 또는 구글 어시스턴트를 실행



=



"Hey Google/헤이 구글" 또는
"Hey Siri/헤이 시리"

또는



음악 재생

재생/일시정지



=



"[뵐-뵐]"

다음곡 이동



=



이전곡 이동



=



빠른 시작 가이드

메시 인터콤™

메시 인터콤 버튼을 눌러 메시 인터콤을 켜면 자동으로 근처의 50S 사용자와 연결되고 서로 대화할 수 있습니다.

메시 인터콤 켜기



"Mesh intercom on/메시 인터콤"

메시 인터콤 끄기



"Mesh intercom off/메시 인터콤 종료"

오픈 메시™

메시 인터콤을 처음에 켜면 헤드셋은 **오픈 메시(기본: 채널 1)** 상태가 됩니다. 동일한 **오픈 메시** 채널에 있는 사용자들은 서로 자유롭게 통신할 수 있습니다.

채널 설정 (기본: 채널 1)

오픈 메시 통신이 **채널 1 (기본)**을 사용 중인 다른 그룹에 의해 간섭될 경우, 채널을 변경하십시오. 채널 1 ~ 9 중에서 선택할 수 있습니다.

빠른 시작 가이드

채널 설정 진입



"Channel setting, 1/채널 설정, 1"



채널 이동

(1 → 2 → ... → 8 → 9 → 종료 → 1 → ...)



"##"



채널 저장



"Channel is set, channel #/
채널이 설정되었습니다, 채널 #"

Note: 채널 설정을 종료하려면 "Exit/종료" 음성안내가 들릴 때까지 조그다이얼을 시계방향 또는 반시계방향으로 돌린 후에 조그다이얼을 짧게 누르십시오.

빠른 시작 가이드

그룹 메시™

그룹 메시는 비개방 그룹 인터콤 기능으로 각 헤드셋 간의 페어링 없이도 사용자가 그룹 인터콤 대화에 참여, 이탈, 재참여 할 수 있습니다. 한 그룹에 최대 24 명이 연결할 수 있습니다.

그룹 메시 생성하기

둘 또는 그 이상의 오픈 메시 사용자들이 **그룹 메시**를 생성할 수 있습니다.

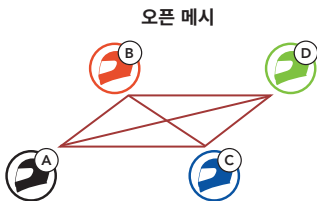

1. **그룹 메시**를 생성하기 위해 **메시 그룹화**에 진입하십시오.



사용자

그리고

=



상대



"Mesh Grouping/메시 그룹화"

빠른 시작 가이드

2. **메시 그룹화**가 완료되고 자동으로 **오픈 메시**에서 **그룹 메시**로 전환됩니다.



"Group Mesh/그룹 메시"

오픈 메시



그룹 메시

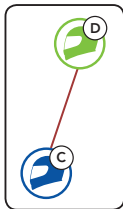

기존 그룹 메시에 참여하기

기존 그룹 메시의 멤버 중 한 명이 **오픈 메시** 상태에 있는 새 멤버를 기존 그룹 메시에 참여시킬 수 있습니다.

새 멤버



기존 그룹 메시 및 현재 멤버

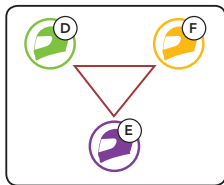

빠른 시작 가이드

1. 기존 메시 그룹에 참여하려면, 현재 멤버 중 한 명과 새 멤버가 메시 그룹화에 진입합니다.



사용자
(새 멤버)

그리고 =



그룹 메시지의
현재 멤버



"Mesh Grouping/메시 그룹화"

2. 헤드셋이 메시 그룹화를 완료합니다. 새 멤버에게 오픈 메시에서 그룹 메시로 전환되는 음성안내가 들립니다.



"Group Mesh/그룹 메시"

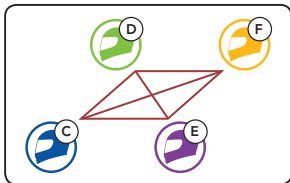

빠른 시작 가이드

메시 초기화

오픈 메시 또는 그룹 메시 상태에서 **메시 초기화**를 진행하면 자동으로 **오픈 메시 (기본: 채널 1)**로 되돌아 갑니다.



마이크 활성화/비활성 (기본: 활성화)

사용자는 **메시 인터콤**으로 통신할 때 마이크를 켜거나 끌 수 있습니다.

마이크 활성화/비활성



빠른 시작 가이드

블루투스 인터콤

최대 세 명과 페어링하여 블루투스 인터콤 대화를 할 수 있습니다.

인터콤 페어링

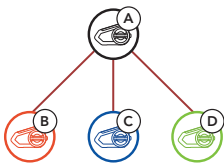

B와 인터콤 페어링



그리고



"Intercom pairing/인터콤 페어링"

50S가 세나 헤드셋과 자동으로 페어링 됩니다.



인터콤 페어링이 완료되면 파란색 LED가 깜빡입니다.

LED 상태

Note: 페어링 과정을 반복하여 인터콤 상대 C, D와 페어링 하십시오.

빠른 시작 가이드

양자 인터콤

마지막 페어링 상대가 첫 번째 인터콤 상대



사용자



인터콤 상대 1



사용자



인터콤 상대 1



인터콤 상대 2



사용자



인터콤 상대 1



인터콤 상대 2



인터콤 상대 3

인터콤 상대 1 과 시작/종료



인터콤 상대 2 와 시작/종료



인터콤 상대 3 과 시작/종료



빠른 시작 가이드

주변소리 모드



FM 라디오

FM 라디오 켜기

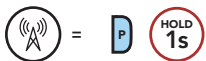

채널 스캔

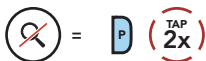
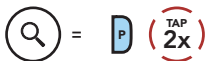

프리셋 채널 이동



FM 라디오 끄기

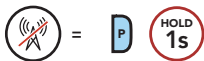

채널 탐색



빠른 시작 가이드

설정메뉴

헤드셋 설정메뉴 진입하기



"Configuration menu/설정메뉴"

메뉴 옵션 이동하기



"[메뉴 안내]"

메뉴 옵션 실행

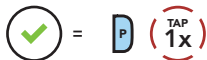

"[메뉴 안내]"

문제해결

공장초기화

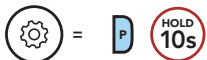

재설정(Fault Reset)

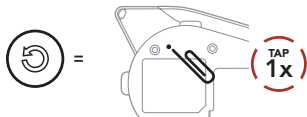

Note: 재설정은 헤드셋을 공장초기값으로 복원하지 않습니다.

빠르게 찾아보기

| 유형 | 조작 | 버튼 조작 |
|--------------------------------------------------------------------------------------------|-----------------|----------------------------------------------------------------------------------------------------------------------------------------------------------------------------------------------------------------------------------------------------------|
|  기본 조작 | 전원 켜기 / 전원 끄기 |    |
| | 음량 키우기 / 음량 줄이기 |    |
| | 주변소리 모드 |   또는  |
|  휴대전화 | 전화 받기 |   |
| | 전화 끊기 |   |
| | 수신 전화 거절 |   |
| | 스피드다이얼 |   |

빠르게 찾아보기

| 유형 | 조작 | 버튼 조작 |
|----------------------------------------------------------------------------------------------------|-------------------|----------------------------------------------------------------------------------------------------------------------------------------------------------------------------------------------------------------------------------------------------------|
|  시리 및 구글 어시스턴트 | 시리 또는 구글 어시스턴트 실행 |   |
|  음악 | 음악 재생/일시정지 |   |
| | 다음곡 이동 |   |
| | 이전곡 이동 |   |
|  FM 라디오 | FM 라디오 켜기/끄기 |   |
| | 프리셋 선택 |   |
| | 이전/다음 탐색 |   또는  |
| | FM 대역 스캔/스캔 중지 |   |

빠르게 찾아보기

| 유형 | 조작 | 버튼 조작 |
|-------------------------------------------------------------------------------------------------|--------------|---------------------------------------------------------------------------------------------|
|  메시 인터콤™ | 메시 인터콤 켜기/끄기 |  (TAP 1x) |
| | 채널 설정 |  (TAP 2x) |
| | 메시 그룹화 |  (HOLD 5s) |
| | 메시 초기화 |  (HOLD 8s) |
| | 마이크 활성화/비활성 |  (HOLD 1s) |
|  인터콤 | 인터콤 페어링 |  (HOLD 5s) |
| | 인터콤 시작 / 종료 |  (TAP 1x) |